

# ZANOLLI CITIZEN PW 9/MC EM

## SINGLE DECK ELECTRIC OVEN WITH STONE BASE, 9 X 34CM CAPACITY

### 2CT3E16B



## ZANOLLI CITIZEN PW SERIES ELECTRIC DECK OVEN

The Zanolli citizen PW electric deck ovens are engineered to withstand the highest demands from the pizzaiola without any compromise on consistent and desired cooking results. Its heavy gauge chassis along with its robust stainless steel construction ensures this oven will serve the test of time. The citizen is also completely modular so you can build up your oven according to your production needs with the possibility to stack up to 3 units. Based on your specialization, you can cook not only different kinds of pizza (round, on the shovel or in pan...) but also a wide range of gastronomy dishes made possible by the accurate and adjustable independent control of the top and bottom resistors. Utilising the maximum oven insulation along with its thick refractory stone floor(s), the citizen produces a stable and consistent cooking environment to produce perfect results and leading thermal efficiency.

## MAIN CHARACTERISTICS

- Athermic full length stainless steel handle
- Armoured stainless steel heating elements, optimized to compensate for heat loss due to door opening
- Independent lighting in each chamber
- Thick heat absorbent refractory ceramic oven floor
- Maximum insulation of the oven chambers for excellent consumption production ratio
- Made entirely of stainless steel
- Heavy duty spring mounted doors with large viewing window in double fireproof glass.
- Manual exhaust valve
- Accommodates 9 x 34cm Pizzas
- Electromechanical control panel with digital display.
- Resistors at the top and bottom of each chamber, adjustable independently.
- Completely Modular - Stackable up to 3 units high



\*Picture shown with three single Citizen PW9 Deck ovens triple stacked and optional triple stand with exhaust canopy.

## DIMENSIONS

External dimensions WxDxH (mm)	1420 X 1310 X 425
Internal dimensions (standard refractory) WxDxH (mm)	1080 X 1050 X 155
Internal dimensions (All refractory option) WxDxH (mm)	1080 X 1050 X 150

## OPTIONS

CITIZEN PW 9 / TP - Exhaust top with fitting for natural draft	OCT7M24
Exhaust Motor kit top with forced suction (capacity 600 m3/h)	ASSM2608
Full refractory lining for baking chamber (per deck)	ASSM1654
Kit of enhanced heating elements (11.2kw to 16.8 kw)	ASSM2160
CITIZEN PW 9 /BM 125 - Single stand - 1420 x 1260 x 1250	OCT5A28
CITIZEN PW 9 /BM 95 - Double stand - 1420 x 1260 x 950	OCT5A27
CITIZEN PW 9 /BM 71 - Triple stand - 1420 x 1260 x 710	OCT5A26
CITIZEN PW 9 /CL 95 - Prover - 1420 x 1260 x 950	OCT5C19
300mm prover support frame for single deck installation	RIAL0045

## SPECIFICATIONS

Capacity (pizzas Ø34cm)	9
Voltage / Electrical Supply (three phase)	three -phase 400Vac 3N 50Hz, supplied with no plug, lead only
Current	16.55 amps at 400Vac 3-N 50Hz
Voltage / Electrical Supply (single phase)	single -phase 230Vac 1-N 50Hz, supplied with no plug, lead only
Current	48.7 amps at 230Vac 1-N 50Hz
Total power	11.2 kw
Average Power	5.7kw
Chambers	1
Cooking Chamber light type	Halogen
Cooking Chamber light power	50 watts
Temp Control	Electronic thermostat
Max temp	400 °C
Power control	separate for oven roof and bedplate
Weight	200 kg
Ambient Temperature	0-40 °C
Maximum humidity	95% without condensation
Warranty	4 year parts 2 years Labour

# ZANOLLI CITIZEN PW 9/MC EM

SINGLE DECK ELECTRIC OVEN WITH STONE BASE, 9 X 34CM CAPACITY  
2CT3E16B



## FRONT

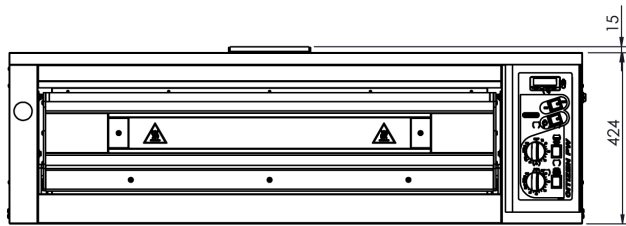

## SIDE

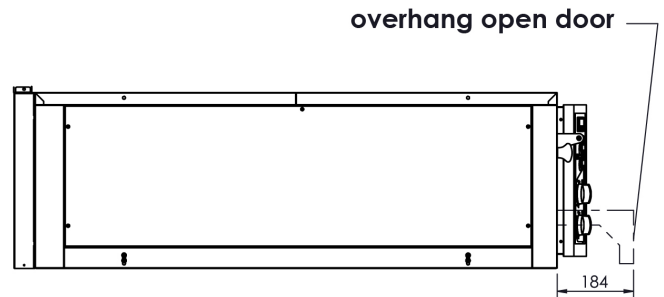

## TOP

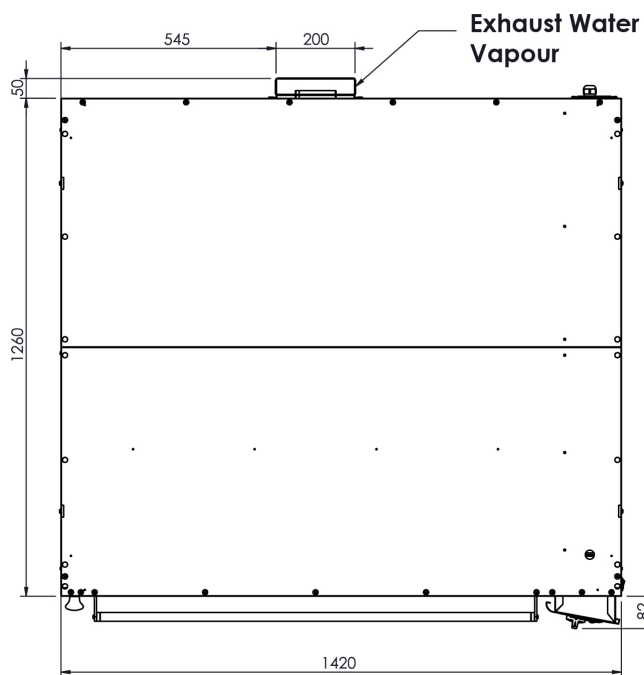

## REAR

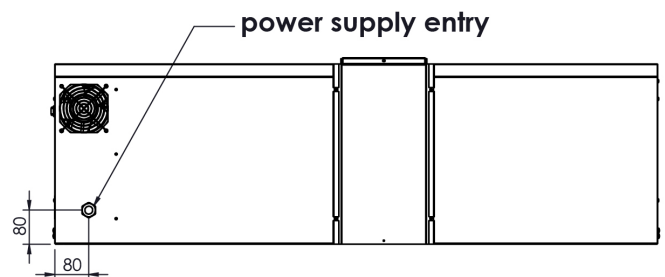

# ZANOLLI CITIZEN PW 9/MC EM

SINGLE DECK ELECTRIC OVEN WITH STONE BASE, 9 X 34CM CAPACITY  
LAYOUT WITH OPTIONAL SINGLE STAND AND EXHAUST CANOPY  
2CT3E16B



## FRONT

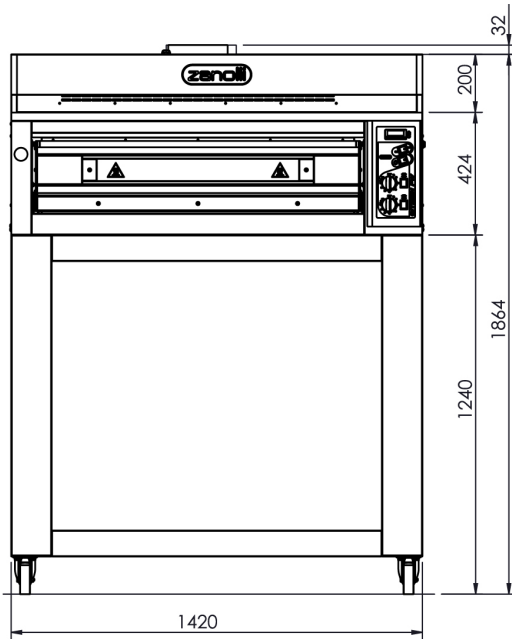

## SIDE

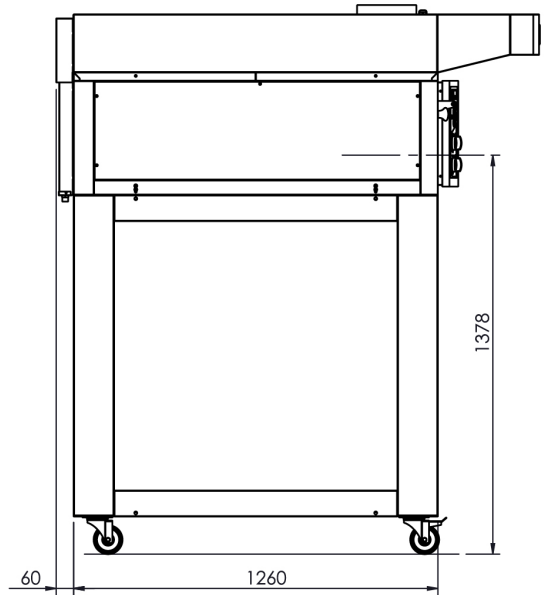

## TOP

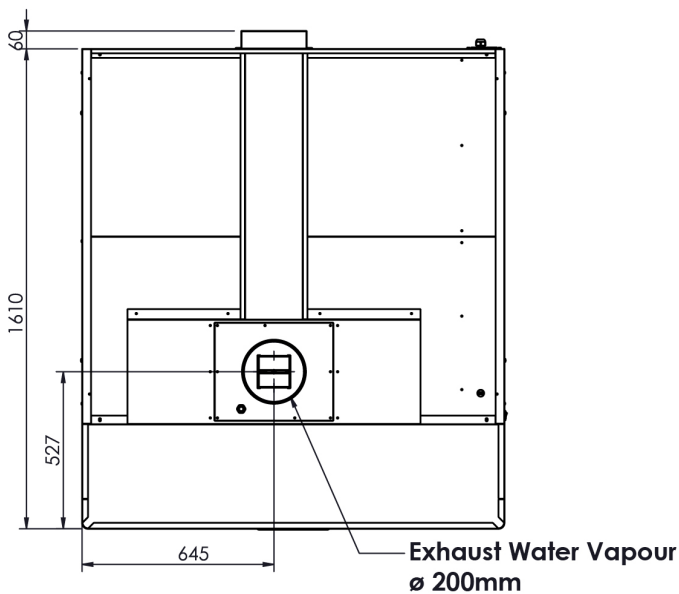

## REAR

